

User manual

Edition 5, July 2021

Hand Warmer

Hand Warmer (P012-62)



mo-vis
moving forward together

Contents

About this manual	7
User manual	7
mo-vis bv	7
User manual (English)	8
Warning labels	8
Support, scrapping & recycling	9
Limited liability	10
Intended use	10
Features	11
Operation	11
Parts and accessories	13
Qualifications	16
First time use	16
Cleaning	17
Warnings and limitations	17
Dimensions	18
Brugermanual (Dansk)	20
Advarselsmærkater	20
Support, bortskaffelse og genbrug	21
Ansvarsbegrænsning	22
Tilsløgt brug	22

Funktioner	23
Betjening	23
Dele og tilbehør	25
Kvalifikationer	28
Brug første gang	29
Rengøring	29
Advarsler og begrænsninger	29
Mål	30
Benutzerhandbuch (Deutsch)	32
Warnhinweise	32
Support, Entsorgung und Recycling	33
Haftungsbeschränkung	34
Vorgesehene Verwendung	35
Merkmale	35
Bedienung	36
Teile und Zubehör	37
Qualifizierungen	40
Erstmalige Verwendung	41
Reinigung	41
Warnungen und Beschränkungen	41
Abmessungen	42
Manual del usuario (Español)	44
Etiquetas de advertencia	44
Asistencia, eliminación y reciclaje	45
Limitación de responsabilidad	46
Uso previsto	46

Características	47
Funcionamiento	48
Componentes y accesorios	49
Personal cualificado	52
Primera utilización	53
Limpieza	53
Advertencias y limitaciones	54
Dimensiones	54
Manuel de l'utilisateur (Français)	56
Étiquettes d'avertissement	56
Assistance, mise au rebut et recyclage	57
Responsabilité limitée	58
Utilisation prévue	58
Fonctionnalités	59
Fonctionnement	60
Pièces et accessoires	61
Qualifications	64
Première utilisation	65
Nettoyage	65
Avertissements et limitations	65
Dimensions	66
Manuale utente (Italiano)	68
Segnaletica di avvertenza	68
Assistenza, smaltimento & riciclaggio	69
Responsabilità limitata	70
Destinazione d'uso	70

Funzioni	71
Funzionamento	72
Parti e accessori	73
Qualifiche	76
Primo utilizzo	77
Pulizia	77
Avvertenze e limiti	78
Dimensioni	79
Brugerhåndbok (Norsk)	80
Advarselsetiketter	80
Brukerstøtte, kassering og gjenvinning	81
Begrenset ansvar	82
Bruksområde	82
Funksjoner	83
Betjening	83
Deler og tilbehør	85
Kvalifikasjoner	88
Første gangs bruk	88
Rengjøring	89
Advarsler og begrensninger	89
Mål	90
Gebruikershandleiding (Nederlands)	92
Waarschuwingslabels	92
Ondersteuning, afdanken en recycling	93
Beperkte aansprakelijkheid	94
Beoogd gebruik	94

Eigenschappen	95
Bediening	96
Onderdelen en accessoires	97
Bevoegdheden	100
Eerste gebruik	101
Reinigen	101
Waarschuwingen en beperkingen	101
Afmetingen	102
Manual do utilizador (Português)	104
Rótulos com advertências	104
Suporte, eliminação e reciclagem	105
Responsabilidade limitada	106
Utilização prevista	106
Funcionalidades	107
Funcionamento	108
Peças e acessórios	109
Qualificações	112
Primeira utilização	113
Limpeza	113
Avisos e limitações	113
Dimensões	114
Användarhandbok (Svenska)	116
Varningsetiketter	116
Support, kassering och återvinning	117
Begränsat ansvar	118
Avsedd användning	118

Funktioner	119
Användning	119
Delar och tillbehör	121
Behörighet	124
Första användningen	125
Rengöring	125
Varningar och begränsningar	126
Mått	127

About this manual

User manual

Thank you for choosing a mo-vis product!

This manual contains **useful and important information** about your device.

Please read it carefully before use and store safely for future reference.

Our team (or your authorized dealer) will be happy to answer your questions.

mo-vis bv

Biebuyckstraat 15D . 9850 Deinze . Belgium

<http://www.mo-vis.com> . contact@mo-vis.com . +32 9 335 28 60



User manual (English)

Warning labels

Please read this manual, the safety instructions and warning texts carefully, in order to reduce the risks associated to the device. Our products are safe under normal and reasonably foreseeable operating conditions.



NOTE: This symbol indicates general notes and information.



CAUTION: This symbol indicates caution for a hazardous situation that, if not avoided, could result in minor or moderate injury.



WARNING: This symbol indicates a warning for a hazardous situation that, if not avoided, could result in death or serious injury.

Support, scrapping & recycling

Technical support



TROUBLE: In case of technical problems:

- Contact your dealer
- If your dealer is not available or unknown, please contact mo-vis: contact@mo-vis.com or +32 9 335 28 60.

Always state the product code and device serial number when contacting us. This ensures you are provided with the correct information.

Spare parts and accessories

Contact mo-vis or your dealer for more information about spare parts and accessories.

Scrapping & recycling



CAUTION: For scrapping, adhere to your local waste legislation. Dispose of obsolete electronic parts responsibly in accordance with local recycling regulations.

Limited liability

*mo-vis accepts **no liability** for personal injury or damage to property that may arise from the failure of the user or other persons to follow the recommendation, warnings and instructions in this manual.*



CAUTION: This product should only be installed by a qualified service engineer.



NOTE: All mo-vis manuals can be found at <http://www.mo-vis.com> where they can be consulted in PDF format.



NOTE: In case any serious incident occurs in relation to this device, this should be reported immediately to mo-vis and the competent authority of the Member State in which the user is established.

Intended use

The Hand Warmer's main functionality is to keep the area around a wheelchair input device warm. This increases the comfort of the users and their ability to control the input device.

It is intended to be fitted on any power chair with 24V connection.

Features

The Hand Warmer:

- is an air heater, powered by the battery power (24V) of a power chair.
- is fully adjustable to individual possibilities and needs with well-thought-out electronics (mini USB connection).
- recycles air instead of using air from the cold environment: it draws air in at the front, heats it and forces it out again at the front using an internal fan. This results in a huge advantage with regards to the power consumption and efficiency.
- a mechanical switch (e.g. mo-vis Twister) can be immediately plugged in (on/off, select power levels) although you also have an on-board push button.
- LED indicates the status of the device.



NOTE: A Perspex dome-shaped 2-hands hood is available to better maintain the air temperature around the hands.

Operation

At the back of the device, a jack connection (1) and push button (2) are provided.



A button connected to the jack connection has the same functionality as the on-board push button.

The functionality of the button is to cycle through the levels (power settings) of the device. See *Installation Manual* for more information.

The green LED at the front indicates the status of the device:

MODE	LED INDICATOR
Sleep mode	Off
Stand-by	Short on, very long off
Active level 1	Short on, long off
Active level 2	Short on, medium off
Active level 3	Short on, short off
Fault	number of flashes, long off (see <i>Installation Manual</i> for more information on the errors and fault log)

Parts and accessories

Hand Warmer set

A Hand Warmer set consists of the following parts:

EXAMPLE**PRODUCT DESCRIPTION**

P012-61 Hand Warmer unit



P012-40 Hand Warmer extension
lead 2000 mm

EXAMPLE	PRODUCT DESCRIPTION
	<p>M012-45 Hand Warmer mounting set:</p> <ul style="list-style-type: none"> • M004-04 Q2M Clamp D6 half + bolt 14 mm • M004-74 Q2M Rod D6 50 mm (1 piece) • M012-40 Hand Warmer dual lock (22*9*3.5 mm): 2 pieces • M004-90 Q2M Rod D6-D8 60mm

D-P012-62-70-MX Hand Warmer User manual

D-P012-62-70-M1 Hand Warmer Installation manual

Optional accessory: Hand Warmer Dome set (M012-31)

To enclose the area around the hand and to better maintain the air temperature, a Perspex dome-shaped hood is available as an option.

This dome:

- reduces heat loss, resulting in a decreased power consumption, without compromising comfort.
- is delivered with 4 hook and loop fastener pads to attach the dome to any flat surface (e.g. a tray).
- has opening that can easily be adjusted, as Perspex is material that can be cut or shaved.



CAUTION: Use proper tools to adjust the dome openings. Warranty is void for any fault as result of adjusting the dome.

Qualifications



CAUTION: Only a qualified service engineer may install the device.



CAUTION: An incorrect programming of the wheelchair or device electronics, may cause damage to the devices or injury to the user.

First time use



CAUTION: Only a qualified service engineer may install the device.



CAUTION: An incorrect programming of the wheelchair or device electronics, may cause damage to the devices or injury to the user.



CAUTION: A qualified service engineer should assist during first time use of the device and make sure that all functions are clear to the user, including what to do in case of problems or doubt.

Cleaning



WARNING: As dust and dirt could lead to reduced functionality, all parts of the device should be cleaned on a regular basis (monthly) or whenever needed.

- Gently remove dust and dirt with a damp cloth.
- Use only non-aggressive disinfectant cleaning agents.



CAUTION: Do not immerse in water or use excessive amounts of liquid.

Warnings and limitations



NOTE: This product complies with the limit values for Electromagnetic Compatibility (EMC) with respect to power wheelchairs, as set out in

the harmonized standards for the EU in the Medical Device Regulation, No. 2017/745.



WARNING:

At full power, the device will produce warm air (up to 80°C/158°F). It is advised to leave a minimum distance between the hand and the Hand Warmer of at least 10 cm (4 in).



If the distance is less, it is necessary to limit the maximum heater temperature (see *Installation manual*).



WARNING: Check daily if the Hand Warmer is still in its correct position and at least 10 cm away from the hands.

Dimensions

Hand Warmer unit

50 mm x 29 mm x 29 mm - 1.97 in x 1.41 in x 1.41 in (HxWxD)

Hand Warmer Dome

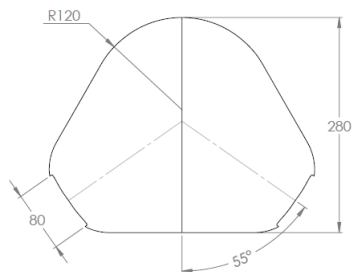

Brugermanual (Dansk)

Advarselmærkater

Læs denne vejledning, sikkerhedsinstruktionerne og advarselsteksterne omhyggeligt for at reducere de risici, der er forbundet med enheden. Vores produkter er sikre under normale og rimeligt forudsigelige driftsbetingelser.



BEMÆRK: Dette symbol angiver generelle bemærkninger og oplysninger.



PAS PÅ: Dette symbol angiver forsigtighed i forbindelse med en farlig situation, der, hvis den ikke undgås, kan resultere i mindre eller moderat personskade.



ADVARSEL: Dette symbol angiver en advarsel om en farlig situation, der, hvis den ikke undgås, kan resultere i død eller alvorlig personskade.

Support, bortskaffelse og genbrug

Teknisk support



FEJLFINDING: In case of technical problems:

- Kontakt din forhandler
- Hvis forhandleren ikke er tilgængelig, eller du ikke ved hvem det er, kan du kontakte mo-vis: contact@mo-vis.com eller +32 9 335 28 60.

Always state the product code and device serial number when contacting us. This ensures you are provided with the correct information.

Reserve dele og tilbehør

Contact mo-vis or your dealer for more information about spare parts and accessories.

Bortskaffelse og genbrug



PAS PÅ: I forbindelse med bortskaffelse skal du følge de lokale affaldsregler. Bortskaf forældede elektroniske dele ansvarligt i henhold til lokale genbrugsregler.

Ansvarsbegrænsning

*mo-vis påtager sig **intet ansvar** for personskade eller beskadigelse af ejendom, der kan opstå som følge af, at brugeren eller andre personer ikke har fulgt anbefalingen, advarslerne og instruktionerne i denne vejledning.*



PAS PÅ: Dette produkt må kun installeres af en kvalificeret servicetekniker.



BEMÆRK: Alle mo-vis manualer kan findes på <http://www.mo-vis.com>, hvor de kan konsulteres i PDF-format.



BEMÆRK: Hvis der opstår en alvorlig hændelse i forbindelse med denne enhed, skal dette straks rapporteres til mo-vis og den kompetente myndighed i den medlemsstat, hvor brugeren er etableret.

Tilsigtet brug

Hand Warmer primære funktion er at holde området omkring en kørestolens styreenhed varmt. Dette øger brugernes komfort og deres evne til at styre styreenheden.

Den er beregnet til at blive monteret på enhver elektrisk stol med 24V-forbindelse.

Funktioner

Hand Warmer:

- er en batteridrevet (24V) luftvarmer til en elektrisk stol.
- is fully adjustable to individual possibilities and needs with well-thought-out electronics (mini USB connection).
- den genbruger luft i stedet for at bruge luft fra de kolde omgivelser: den trækker luft ind foran, opvarmer den og tvinger den ud igen foran ved hjælp af en intern blæser. Dette resulterer i en enorm fordel med hensyn til strømforbrug og effektivitet.
- en mekanisk kontakt (fx mo-vis Twister) kan med det samme tilsluttes (tænd/sluk, vælg effektniveau), selvom du også har en trykknop indbygget.
- LED, der angiver enhedens status.



BEMÆRK: Der fås en Perspex kuppelformet 2-håndshætte for bedre at opretholde lufttemperaturen omkring hænderne.

Betjening

På bagsiden af enheden findes der en stikforbindelse (1) og en trykknop (2).



En knap, der er forbundet til stikforbindelsen, har samme funktionalitet som den indbyggede trykknop.

Knappens funktion er at skifte gennem enhedens niveauer (strømindstillinger). Se *Installationsmanualen* for yderligere oplysninger.

Den grønne LED foran angiver enhedens status:

TILSTAND	LED-INDIKATOR
Dvaletilstand	Slukket
Standby	Kort tændt, meget langt slukket
Aktiv niveau 1	Kort tændt, langt slukket
Aktiv niveau 2	Kort tændt, medium slukket
Aktiv niveau 3	Kort tændt, kort slukket
Fejl	antal blink, langt slukket (se <i>Installationsmanualen</i> for yderligere oplysninger op fejl og fejlloggen)

Dele og tilbehør

Hand Warmer set

Et Hand Warmer set består af følgende dele:

EKSEMPEL**PRODUKTBESKRIVELSE**

P012-61 Hand Warmer unit



P012-40 Hand Warmer extension
lead 2000 mm

EKSEMPEL	PRODUKTBESKRIVELSE
	<p>M012-45 Hand Warmer mounting set:</p> <ul style="list-style-type: none"> • M004-04 Q2M Clamp D6 half + bolt 14 mm • M004-74 Q2M Rod D6 50 mm (1 stk.) • M012-40 Hand Warmer dual lock (22*9*3,5 mm): 2 stk. • M004-90 Q2M Rod D6-D8 60mm

Brugermanual til D-P012-62-70-MX Hand Warmer

Installationsmanual til D-P012-62-70-M1 Hand Warmer

Ekstra tilbehør: Hand Warmer Dome set (M012-31)

For at omslutte området omkring hånden og for bedre at opretholde lufttemperaturen fås en Perspex kuppelformet hætte som ekstraudstyr.

Denne kuppel:

- reducerer varmetab, hvilket resulterer i et reduceret strømforbrug uden at gå på kompromis med komforten.
- leveres med 4 fastgørelsespuder med krog og løkke til fastgørelse af kuplen til enhver flad overflade (f.eks. en bakke).
- har en åbning, der let kan justeres, da Perspex er et materiale, der kan skæres i eller skæres til.



PAS PÅ: Brug korrekte værktøjer til at justere kuplens åbninger. Garantien er ugyldig for enhver fejl som følge af justering af kuplen.

Kvalifikationer



PAS PÅ: Kun en kvalificeret servicetekniker må installere enheden.



PAS PÅ: En forkert programmering af kørestolen eller enhedens elektronik kan forårsage beskadigelse af enhederne eller skade på brugeren.

Brug første gang



PAS PÅ: En kvalificeret servicetekniker bør bistå ved første brug af enheden og sikre, at brugeren forstår alle funktioner, herunder hvad vedkommende skal gøre i tilfælde af problemer eller tvivl.

Rengøring



ADVARSEL: As dust and dirt could lead to reduced functionality, all parts of the device should be cleaned on a regular basis (monthly) or whenever needed.

- Gently remove dust and dirt with a damp cloth.
- Use only non-aggressive disinfectant cleaning agents.



PAS PÅ: Do not immerse in water or use excessive amounts of liquid.

Advarsler og begrænsninger



BEMÆRK: This product complies with the limit values for Electromagnetic Compatibility (EMC) with respect to power wheelchairs, as set out in the harmonized standards for the EU in the Medical Device Regulation, No. 2017/745.

**ADVARSEL:**

At full power, the device will produce warm air (up to 80°C/158°F). It is advised to leave a minimum distance between the hand and the Hand Warmer of at least 10 cm (4 in).



Hvis afstanden er mindre, er det nødvendigt at begrænse den maksimale varmertemperatur (se *Installationsmanualen*).



ADVARSEL: Kontrollér dagligt, om Hand Warmer stadig er korrekt placeret og mindst 10 cm væk fra hænderne.

Mål

Hand Warmer unit

50 mm x 29 mm x 29 mm - 1,97 in x 1,41 in x 1,41 in (HxBxD)

Hand Warmer Dome

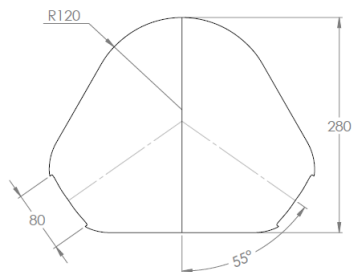

Benutzerhandbuch (Deutsch)

Warnhinweise

Lesen Sie diese Anleitung, die Sicherheitshinweise und Warntexte sorgfältig, um die mit dem Gerät verbundenen Risiken zu reduzieren. Unsere Produkte sind unter normalen und vernünftigerweise vorhersehbaren Betriebsbedingungen sicher.



ANMERKUNG: Dieses Symbol verweist auf allgemeine Hinweise und Informationen.



ACHTUNG: Dieses Symbol verweist auf eine gefährliche Situation, die zu leichten oder mittelschweren Verletzungen führen kann, wenn sie nicht vermieden wird.



WARNUNG: Dieses Symbol verweist auf eine Warnung hinsichtlich einer gefährlichen Situation, die zum Tod oder zu schwerwiegenden Verletzungen führen kann, wenn sie nicht vermieden wird.

Support, Entsorgung und Recycling

Technischer Support



PROBLEM: In case of technical problems:

- Wenden Sie sich an den Händler
- Ist der Händler nicht verfügbar oder unbekannt, wenden Sie sich bitte per E-Mail (contact@mo-vis.com) oder Telefon (+32 9 335 28 60) an mo-vis.

Always state the product code and device serial number when contacting us. This ensures you are provided with the correct information.

Ersatzteile und Zubehör

Contact mo-vis or your dealer for more information about spare parts and accessories.

Entsorgung und Recycling



ACHTUNG: Befolgen Sie bei der Entsorgung Ihre örtlichen Abfallgesetze. Entsorgen Sie veraltete elektronische Teile verantwortungsbewusst in Übereinstimmung mit den örtlichen Recyclingbestimmungen.

Haftungsbeschränkung

*mo-vis übernimmt **keine Haftung** für Verletzungen oder Sachbeschädigungen, die dadurch entstehen, dass der Benutzer oder andere Personen die Empfehlungen, Warnhinweise und Anweisungen in diesem Handbuch außer Acht lassen.*



ACHTUNG: Dieses Produkt darf ausschließlich von einem qualifizierten Servicetechniker installiert werden.



ANMERKUNG: Sie finden alle mo-vis-Anleitungen unter <http://www.mo-vis.com>, wo Sie sie im PDF-Format herunterladen können.



ANMERKUNG: Falls ein schwerwiegender Vorfall im Zusammenhang mit diesem Gerät auftreten sollte, ist dieser unverzüglich mo-vis und der zuständigen Behörde des Mitgliedsstaats, in dem der Benutzer niedergelassen ist, mitzuteilen.

Vorgesehene Verwendung

Der Hand Warmer dient in erster Linie dazu, den Bereich rund um das Eingabegerät am Rollstuhl warm zu halten. Hierdurch erhöht sich der Komfort für die Benutzer und vereinfacht diesen die Bedienung des Eingabegeräts.

Das Gerät ist für den Anbau an einen Elektro-Rollstuhl mit 24-V-Anschluss vorgesehen.

Merkmale

Der Hand Warmer:

- ist ein Luftheritzer, der über den Akku (24 V) eines Elektro-Rollstuhls betrieben wird.
- is fully adjustable to individual possibilities and needs with well-thought-out electronics (mini USB connection).
- recycelt Luft, anstatt kalte Umgebungsluft zu nutzen. Er saugt die Luft an der Vorderseite an, erwärmt sie und stößt sie über einen internen Lüfter an der Vorderseite wieder aus. Dies bietet einen großen Vorteil in Bezug auf Stromverbrauch und Effizienz.
- Ein mechanischer Schalter (z. B. mo-vis Twister) kann sofort angeschlossen werden (ein/aus, Auswahl der Leistungsstufen), aber es gibt auch eine integrierte Drucktaste.
- Eine LED zeigt den Status des Geräts an.



ANMERKUNG: Eine Perspex-Schutzhaube für beide Hände ist verfügbar, um die Lufttemperatur rund um die Hände besser zu halten.

Bedienung

Die Rückseite des Geräts ist mit einer Klinkenbuchse (1) und einer Drucktaste (2) versehen.



Eine an die Klinkenbuchse angeschlossene Taste bietet die gleiche Funktionalität wie die geräteeigene Drucktaste.

Mit der Taste werden die einzelnen Stufen (Stromeinstellungen) des Geräts geregelt. Weitere Informationen finden sich im *Installationshandbuch*.

Die grüne LED an der Vorderseite zeigt den Status des Geräts an:

MODUS	LED-ANZEIGE
Schlafmodus	Aus
Stand-by	Kurz an, sehr lange aus
Aktivitätenstufe 1	Kurz an, lange aus
Aktivitätenstufe 2	Kurz an, mittellang aus
Aktivitätenstufe 3	Kurz an, kurz aus
Störung	Mehrere Blinksignale, lange aus (siehe das <i>Installationshandbuch</i> für weitere Informationen zu den Fehlern und dem Fehlerprotokoll)

Teile und Zubehör

Hand Warmer set

Ein Hand Warmer set umfasst die folgenden Teile:

BEISPIEL**PRODUKTBESCHREIBUNG**

P012-61 Hand Warmer unit



P012-40 Hand Warmer extension
lead 2000 mm

BEISPIEL	PRODUKTBESCHREIBUNG
	<p>M012-45 Hand Warmer mounting set:</p> <ul style="list-style-type: none"> • M004-04 Q2M Clamp D6 half + bolt 14 mm • M004-74 Q2M Rod D6 50 mm (1 Stück) • M012-40 Hand Warmer dual lock (22*9*3,5 mm): 2 Stück • M004-90 Q2M Rod D6-D8 60mm

D-P012-62-70-MX Hand Warmer-Benutzerhandbuch

D-P012-62-70-M1 Hand Warmer-Installationshandbuch

Optionales Zubehör: Hand Warmer Dome set (M012-31)

Um den Bereich über der Hand zu schützen und die warme Temperatur besser zu halten, ist optional die Perspex-Schutzhaube erhältlich.

Diese Schutzhaube:

- verhindert den Wärmeverlust und verringert somit den Stromverbrauch, ohne den Komfort zu beeinträchtigen;
- wird mit 4 Klettverschlusspolstern geliefert, um die Schutzhaube an einer beliebigen flachen Oberfläche (z. B. einem Tablett) zu befestigen;
- verfügt über Öffnungen, die bequem angepasst werden können, da das Material Perspex leicht zugeschnitten oder abgetragen werden kann.



ACHTUNG: Verwenden Sie für den Zuschnitt der Schutzhaubenöffnungen geeignetes Werkzeug. Bei einer fehlerhaften Anpassung der Schutzhaube verfällt die Garantie.

Qualifizierungen



ACHTUNG: Das Gerät darf nur von einem qualifizierten Servicetechniker installiert werden.



ACHTUNG: Eine falsche Programmierung der Rollstuhl- oder Geräteelektronik kann zur Beschädigung des Geräts führen oder den Benutzer verletzen.

Erstmalige Verwendung



ACHTUNG: Bei der ersten Verwendung des Geräts sollten Sie sich von einem qualifizierten Servicetechniker unterstützen lassen, der sicherstellt, dass dem Benutzer alle Funktionen klar sind, darunter auch, was im Fall von Problemen oder Unsicherheiten zu tun ist.

Reinigung



WARNUNG: As dust and dirt could lead to reduced functionality, all parts of the device should be cleaned on a regular basis (monthly) or whenever needed.

- Gently remove dust and dirt with a damp cloth.
- Use only non-aggressive disinfectant cleaning agents.



ACHTUNG: Do not immerse in water or use excessive amounts of liquid.

Warnungen und Beschränkungen



ANMERKUNG: This product complies with the limit values for Electromagnetic Compatibility (EMC) with respect to power

wheelchairs, as set out in the harmonized standards for the EU in the Medical Device Regulation, No. 2017/745.



WARNUNG:

At full power, the device will produce warm air (up to 80°C/158°F). It is advised to leave a minimum distance between the hand and the Hand Warmer of at least 10 cm (4 in).



Wenn der Abstand geringer ist, muss die maximale Temperatur des Heizgeräts begrenzt werden (siehe *Installationshandbuch*).



WARNUNG: Prüfen Sie täglich, ob sich der Hand Warmer nach wie vor in der korrekten Position und in einem Abstand von mindestens 10 cm zu den Händen befindet.

Abmessungen

Hand Warmer unit

50 mm x 29 mm x 29 mm (HxBxT)

Hand Warmer Dome

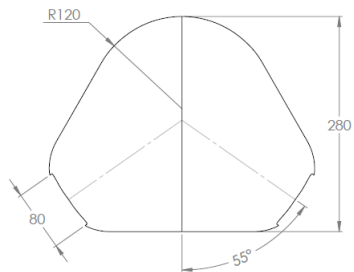

Manual del usuario (Español)

Etiquetas de advertencia

Lea con atención este manual, las instrucciones de seguridad y los textos de advertencia para reducir los riesgos asociados al dispositivo. Nuestros productos son seguros en condiciones de funcionamiento normales y previsibles.



NOTA: Este símbolo indica notas e información de tipo general.



PRECAUCIÓN: Este símbolo indica precaución por situaciones peligrosas que, de no evitarse, podrían provocar lesiones leves o moderadas.



AVISO: Este símbolo indica una advertencia por situaciones peligrosas que, de no evitarse, podrían provocar lesiones graves o la muerte.

Asistencia, eliminación y reciclaje

Asistencia técnica



PROBLEMA: In case of technical problems:

- Contacto con su distribuidor
- Si no sabe cuál es su distribuidor o no está disponible, póngase en contacto con mo-vis: contact@mo-vis.com o llame al +32 9 335 28 60.

Always state the product code and device serial number when contacting us. This ensures you are provided with the correct information.

Repuestos y accesorios

Contact mo-vis or your dealer for more information about spare parts and accessories.

Eliminación y reciclaje



PRECAUCIÓN: Para eliminar el dispositivo, respete la normativa sobre eliminación de residuos de su localidad. La eliminación de componentes electrónicos viejos debe realizarse de forma responsable y de conformidad con la legislación en materia de reciclaje de cada localidad.

Limitación de responsabilidad

*mo-vis declina **toda responsabilidad** en caso de lesiones físicas o daños materiales derivados del incumplimiento por parte del usuario o de otras personas de las recomendaciones, advertencias e instrucciones de este manual.*



PRECAUCIÓN: La instalación del producto debe dejarse exclusivamente en manos de un técnico de servicio cualificado.



NOTA: Todos los manuales de mo-vis están disponibles en <http://www.mo-vis.com>, donde pueden consultarse en formato PDF.



NOTA: En caso de incidente grave relacionado con este dispositivo, debe comunicarse de inmediato a mo-vis y a las autoridades competentes del país de residencia del usuario.

Uso previsto

La principal función del Hand Warmer es mantener caliente la zona próxima al dispositivo de entrada de una silla de ruedas. De este modo mejora

el confort de los usuarios y su capacidad para controlar el dispositivo de entrada.

Está pensado para montarse en cualquier silla de ruedas eléctrica con conexión de 24 V.

Características

El Hand Warmer:

- es un calefactor de aire alimentado por la batería (24 V) de una silla de ruedas eléctrica.
- is fully adjustable to individual possibilities and needs with well-thought-out electronics (mini USB connection).
- recicla el aire en lugar de usar aire frío: obtiene el aire de entrada por la parte delantera, lo calienta y lo expulsa de nuevo a la parte delantera a través de un ventilador interno. El resultado es una gran ventaja en términos de consumo de energía y eficiencia.
- permite conectar un interruptor mecánico (como el mo-vis Twister) de forma inmediata (encendido/apagado, selección de niveles de potencia), aunque también puede disponer de un pulsador integrado.
- El LED indica el estado del dispositivo.



NOTA: Hay disponible una tapa de Perspex de forma cónica para 2 manos para mantener la temperatura en la zona de las manos.

Funcionamiento

En la parte posterior del dispositivo, hay una conexión para una toma (1) y un pulsador (2).



Un botón conectado a la conexión de toma tiene la misma funcionalidad que el pulsador integrado.

La función del botón es cambiar entre los niveles (ajustes de potencia) del dispositivo. Consulte el *Manual de instalación* para obtener más información.

El LED verde de la parte delantera indica el estado del dispositivo:

MODO	INDICADOR LED
Modo de suspensión	Desactivado
Espera	Encendido breve, apagado muy largo
Nivel activo 1	Encendido breve, apagado largo
Nivel activo 2	Encendido breve, apagado medio
Nivel activo 3	Encendido breve, apagado breve
Fallo	número de parpadeos, apagado largo (ver el <i>Manual de instalación</i> para obtener más información sobre los errores y el registro de fallos).

Componentes y accesorios

Hand Warmer set

Un Hand Warmer set incluye los siguientes componentes:

EJEMPLO**DESCRIPCIÓN DEL PRODUCTO**

P012-61 Hand Warmer unit



P012-40 Hand Warmer extension
lead 2000 mm



EJEMPLO	DESCRIPCIÓN DEL PRODUCTO
 <p>The image shows the components of a hand warmer mounting set: a metal clamp with a bolt, two black rods of different lengths, and two small rectangular dual-lock fasteners with red and white markings.</p>	<p>M012-45 Hand Warmer mounting set:</p> <ul style="list-style-type: none"> • M004-04 Q2M Clamp D6 half + bolt 14 mm • M004-74 Q2M Rod D6 50 mm (1 unidad) • M012-40 Hand Warmer dual lock (22*9*3,5 mm): 2 unidades • M004-90 Q2M Rod D6-D8 60mm

Manual del usuario del Hand Warmer D-P012-62-70-MX

Manual de instalación del Hand Warmer D-P012-62-70-M1

Accesorio opcional: Hand Warmer Dome set (M012-31)

Para resguardar la zona alrededor de la mano y mantener mejor la temperatura del aire, hay disponible de forma opcional una tapa en forma de cúpula de Perspex.

Esta cúpula:

- reduce las pérdidas térmicas, lo que disminuye el consumo de energía sin perjudicar el confort.
- incluye 4 tiras de fijación de gancho y bucle para fijar la cúpula a cualquier superficie lisa (como una bandeja).
- tiene una abertura fácil de ajustar, ya que el Perspex es un material que puede cortarse o rebajarse.



PRECAUCIÓN: Utilice herramientas adecuadas para ajustar las aberturas de la cúpula. La garantía quedará anulada por errores en el ajuste de la cúpula.

Personal cualificado



PRECAUCIÓN: Solo un técnico de servicio cualificado puede instalar el dispositivo.



PRECAUCIÓN: Una programación incorrecta de la silla de ruedas o el sistema electrónico del dispositivo puede provocar daños en los equipos o lesiones en el usuario.

Primera utilización



PRECAUCIÓN: Un técnico de servicio cualificado debe estar presente la primera vez que se utilice el dispositivo para asegurarse de que el usuario tiene claras todas las funciones y también qué hacer en caso de duda.

Limpieza



AVISO: As dust and dirt could lead to reduced functionality, all parts of the device should be cleaned on a regular basis (monthly) or whenever needed.

- Gently remove dust and dirt with a damp cloth.
- Use only non-aggressive disinfectant cleaning agents.



PRECAUCIÓN: Do not immerse in water or use excessive amounts of liquid.

Advertencias y limitaciones



NOTA: This product complies with the limit values for Electromagnetic Compatibility (EMC) with respect to power wheelchairs, as set out in the harmonized standards for the EU in the Medical Device Regulation, No. 2017/745.



AVISO:

At full power, the device will produce warm air (up to 80°C/158°F). It is advised to leave a minimum distance between the hand and the Hand Warmer of at least 10 cm (4 in).



Si la distancia es inferior, es necesario limitar la temperatura máxima del calefactor (ver el *Manual de instalación*).



AVISO: Compruebe cada día si el Hand Warmer sigue en su posición correcta y a por lo menos 10 cm de las manos.

Dimensiones

Hand Warmer unit

50 mm x 29 mm x 29 mm (AlxAnxPr)

Hand Warmer Dome

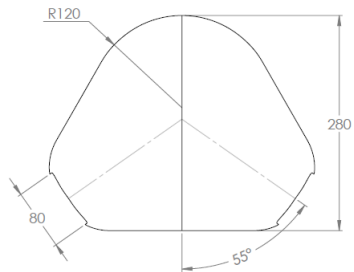

Manuel de l'utilisateur (Français)

Étiquettes d'avertissement

Veillez lire attentivement le manuel, les mesures de sécurité et les textes d'avertissement afin de réduire les risques liés à l'appareil. Nos produits sont sûrs dans des conditions de fonctionnement normales et raisonnablement prévisibles.



REMARQUE: Ce symbole indique les remarques et les informations générales.



ATTENTION: Ce symbole indique une mise en garde contre une situation dangereuse qui, si elle n'est pas évitée, peut entraîner des blessures mineures ou modérées.



AVERTISSEMENT: Ce symbole indique un avertissement contre une situation dangereuse qui, si elle n'est pas évitée, peut entraîner des blessures sérieuses ou la mort.

Assistance, mise au rebut et recyclage

Assistance technique



PROBLÈME: In case of technical problems:

- Contactez votre revendeur
- Si votre revendeur n'est pas disponible ou si vous ne savez pas de qui il s'agit, veuillez contacter mo-Vis : par e-mail à contact@mo-vis.com ou par téléphone au +32 9 335 28 60.

Always state the product code and device serial number when contacting us. This ensures you are provided with the correct information.

Pièces de rechange et accessoires

Contact mo-vis or your dealer for more information about spare parts and accessories.

Mise au rebut et recyclage



ATTENTION: Veuillez vous conformer aux réglementations locales en matière de mise au rebut. Veuillez éliminer les éléments électroniques obsolètes de manière responsable en conformité avec les réglementations locales en matière de recyclage.

Responsabilité limitée

*mo-vis n'est **nullement responsable** des blessures corporelles ou des dommages pouvant résulter du non-respect par l'utilisateur ou d'autres personnes des recommandations, avertissements et instructions repris dans ce manuel.*



ATTENTION: Ce produit ne doit être installé que par un technicien agréé.



REMARQUE: Tous les manuels mo-vis sont disponibles sur le site <http://www.mo-vis.com> et peuvent être consultés au format PDF.



REMARQUE: En cas d'incident grave associé à cet appareil, signalez-le immédiatement à mo-vis et à l'autorité compétente de l'État membre dans lequel l'utilisateur est établi.

Utilisation prévue

Le rôle principal du Hand Warmer est de maintenir au chaud la zone située autour du dispositif d'entrée du fauteuil roulant. Cela augmente le confort des utilisateurs et leur aptitude à contrôler le dispositif d'entrée.

Ce chauffe-mains est destiné à être installé sur tout fauteuil roulant électronique doté d'une prise 24 V.

Fonctionnalités

Le Hand Warmer :

- est un générateur d'air chaud, alimenté par la batterie (24 V) d'un fauteuil électronique.
- is fully adjustable to individual possibilities and needs with well-thought-out electronics (mini USB connection).
- recycle l'air au lieu d'utiliser l'air froid ambiant : l'air est aspiré par l'avant, réchauffé et soufflé par l'avant à l'aide d'un ventilateur interne. Cela a pour effet de réduire la consommation d'énergie et d'accroître l'efficacité du chauffe-mains.
- Un contacteur mécanique (par ex., mo-vis Twister) peut immédiatement être branché (marche/arrêt, sélection des niveaux de puissance) bien que vous disposiez également d'un bouton-poussoir embarqué.
- La LED indique le statut de l'appareil.



REMARQUE: Un dôme en Perspex à deux mains est disponible pour mieux conserver la température de l'air autour des mains.

Fonctionnement

Une prise jack (1) et un bouton-poussoir (2) figurent au dos de l'appareil.



Un contacteur connecté à la prise jack a la même fonctionnalité qu'un bouton-poussoir intégré.

La fonctionnalité du contacteur est de parcourir les niveaux (paramètres de puissance) de l'appareil. Veuillez vous reporter au *Manuel d'installation* pour en savoir plus.

Le témoin LED vert à l'avant indique l'état de l'appareil :

MODE	INDICATEUR LED
Mode veille	Off (arrêt)
En attente	Allumé brièvement, éteint très longtemps
Niveau actif 1	Allumé brièvement, éteint longtemps
Niveau actif 2	Allumé brièvement, éteint moyen
Niveau actif 3	Allumé brièvement, éteint brièvement
Erreur	Nombre de clignotements, éteint longtemps (voir le <i>Manuel d'installation</i> pour en savoir plus sur les erreurs et le journal d'erreurs)

Pièces et accessoires

Hand Warmer set

Un Hand Warmer set se compose des éléments suivants :

EXEMPLE**DESCRIPTION DU PRODUIT**

P012-61 Hand Warmer unit



P012-40 Hand Warmer extension
lead 2000 mm

EXEMPLE	DESCRIPTION DU PRODUIT
 <p>The image shows the components of the M012-45 Hand Warmer mounting set. From left to right: a metal bolt with a black plastic clamp attached, a long black rod, a shorter black rod, and two small rectangular dual lock components with red and white markings.</p>	<p>M012-45 Hand Warmer mounting set :</p> <ul style="list-style-type: none"> • M004-04 Q2M Clamp D6 half + bolt 14 mm • M004-74 Q2M Rod D6 50 mm (1 pièce) • M012-40 Hand Warmer dual lock (22*9*3,5 mm) : 2 pièces • M004-90 Q2M Rod D6-D8 60mm

D-P012-62-70-MX Manuel de l'utilisateur du Hand Warmer

D-P012-62-70-M1 Manuel d'installation du Hand Warmer

Accessoire en option : Hand Warmer Dome set (M012-31)

Afin de refermer la zone autour des mains et de mieux conserver la température de l'air, un dôme en Perspex est disponible en option.

Ce dôme :

- permet de minimiser la perte de chaleur, ce qui réduit la consommation d'énergie, sans compromettre le confort.
- est livré avec quatre fermetures à bouclettes pour l'attacher sur toute surface plane (par exemple, un plateau).
- possède des ouvertures pouvant être ajustées en toute simplicité, le Perspex étant un matériau facile à couper ou à raboter.



ATTENTION: Utilisez des outils adéquats pour les ouvertures du dôme. La garantie est nulle et non avenue si l'erreur est due à un réglage du dôme.

Qualifications



ATTENTION: Seul un technicien agréé peut installer l'appareil.



ATTENTION: Une programmation incorrecte des composants électroniques du fauteuil roulant ou de l'appareil peut endommager les appareils ou blesser l'utilisateur.

Première utilisation



ATTENTION: Un technicien agréé doit apporter son aide lors de la première utilisation de l'appareil et s'assurer que toutes les fonctions sont claires pour l'utilisateur, y compris ce qu'il faut faire en cas de problème ou de doute.

Nettoyage



AVERTISSEMENT: As dust and dirt could lead to reduced functionality, all parts of the device should be cleaned on a regular basis (monthly) or whenever needed.

- Gently remove dust and dirt with a damp cloth.
- Use only non-aggressive disinfectant cleaning agents.



ATTENTION: Do not immerse in water or use excessive amounts of liquid.

Avertissements et limitations



REMARQUE: This product complies with the limit values for Electromagnetic Compatibility (EMC) with respect to power

wheelchairs, as set out in the harmonized standards for the EU in the Medical Device Regulation, No. 2017/745.



AVERTISSEMENT:

At full power, the device will produce warm air (up to 80°C/158°F). It is advised to leave a minimum distance between the hand and the Hand Warmer of at least 10 cm (4 in).



Si la distance est inférieure, il est nécessaire de limiter la température maximale du chauffe-mains (voir le *Manuel d'installation*).



AVERTISSEMENT: Assurez-vous quotidiennement que le Hand Warmer est maintenu dans la position recommandée et éloigné d'au moins 10 cm des mains.

Dimensions

Hand Warmer unit

50 mm x 29 mm x 29 mm - 1,97 po x 1,41 po x 1,41 po (HxIxP)

Hand Warmer Dome

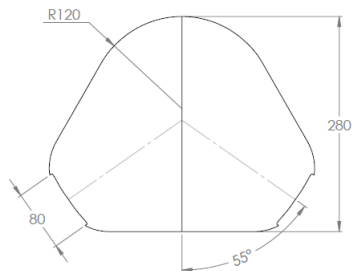

Manuale utente (Italiano)

Segnaletica di avvertenza

Leggere il presente manuale, le istruzioni di sicurezza e le avvertenze in modo da ridurre i rischi legati all'utilizzo del dispositivo. I nostri prodotti sono sicuri in presenza di condizioni d'uso normali e ragionevolmente prevedibili.



NOTA: Il simbolo indica le note e le informazioni generali.



AVVERTENZA: Il simbolo indica attenzione in presenza di situazioni di pericolo che, se non evitate, potrebbero causare lesioni di bassa e media gravità.



AVVERTENZA: Il simbolo indica attenzione in presenza di situazioni di pericolo che, se non evitate, potrebbero causare lesioni gravi o la morte.

Assistenza, smaltimento & riciclaggio

Assistenza tecnica



PROBLEMA: In case of technical problems:

- Contattare il proprio rivenditore di riferimento
- Se il rivenditore di riferimento non fosse disponibile o fosse sconosciuto, contattare mo-vis: contact@mo-vis.com o +32 9 335 28 60.

Always state the product code and device serial number when contacting us. This ensures you are provided with the correct information.

Pezzi di ricambio e accessori

Contact mo-vis or your dealer for more information about spare parts and accessories.

Smaltimento e riciclaggio



AVVERTENZA: Per lo smaltimento rispettare le normative locali sui rifiuti. Smaltire le parti elettroniche obsolete rispettando i regolamenti locali in materia di riciclaggio.

Responsabilità limitata

*mo-vis non si assume **alcuna responsabilità** per lesioni personali o danni causati dalla manca osservanza delle raccomandazioni, delle avvertenze e delle altre istruzioni del presente manuale da parte dell'utilizzatore o di un'altra persona.*



AVVERTENZA: Questo prodotto deve essere installato solo da un tecnico qualificato.



NOTA: Tutti i manuali mo-vis si trovano in <http://www.mo-vis.com> dove possono essere consultati in formato PDF.



NOTA: In caso di incidente grave legato al presente dispositivo, questo dovrà essere comunicato immediatamente a mo-vis e all'autorità di vigilanza dello Stato membro in cui si trova l'utilizzatore.

Destinazione d'uso

La funzionalità principale dell'Hand Warmer è quella di mantenere calda l'area intorno a un dispositivo di input per sedia a rotelle. Ciò aumenta il comfort degli utenti e la loro capacità di controllare il dispositivo di input.

È progettato per essere montato su qualsiasi sedia a rotelle elettrica con connessione a 24 V.

Funzioni

Il Hand Warmer:

- è un riscaldatore dell'aria, alimentato a batteria (24V) per una sedia a rotelle elettrica.
- is fully adjustable to individual possibilities and needs with well-thought-out electronics (mini USB connection).
- ricicla l'aria invece di utilizzare l'aria dell'ambiente freddo: aspira l'aria frontalmente, la riscalda e la espelle di nuovo frontalmente tramite una ventola interna. Ciò si traduce in un enorme vantaggio in termini di consumo di energia e di efficienza.
- un interruttore meccanico (ad es. mo-vis Twister) può essere collegato direttamente (livelli di selezione potenza on/off) anche se è possibile utilizzare un pulsante a bordo.
- Il LED indica lo stato del dispositivo.



NOTA: È disponibile una cappa a cupola per 2 mani Perspex per mantenere meglio la temperatura dell'aria attorno alle mani.

Funzionamento

Sul retro del dispositivo sono predisposti un jack di collegamento (1) e un pulsante (2).



Un pulsante connesso al jack di collegamento ha le stesse funzionalità del pulsante di bordo.

La funzionalità del pulsante è permettere lo scorrimento dei livelli (impostazioni di alimentazione) del dispositivo. Per ulteriori informazioni consultare il *Manuale di installazione*.

Il LED verde nella parte anteriore indica lo stato del dispositivo:

MODALITÀ	INDICATORE LED
Modalità di sospensione	Off
Stand-by	Breve attivo, molto lungo spento
Livello attivo 1	Breve attivo, lungo spento
Livello attivo 2	Breve attivo, medio spento
Livello attivo 3	Breve attivo, corto spento
Guasto	numero di lampeggi, lungo spento (consultare il <i>Manuale di installazione</i> per maggiori informazioni sugli errori e sul registro guasti)

Parti e accessori

Hand Warmer set

Un Hand Warmer set comprende le seguenti parti:

ESEMPIO**DESCRIZIONE DEL PRODOTTO**

P012-61 Hand Warmer unit



P012-40 Hand Warmer extension
lead 2000 mm

ESEMPIO	DESCRIZIONE DEL PRODOTTO
 <p>The image shows the components of a hand warmer mounting set: a metal clamp with a hole, a long black rod, a shorter black rod, and two small rectangular dual-lock fasteners with red and white markings.</p>	<p>M012-45 Hand Warmer mounting set:</p> <ul style="list-style-type: none"> • M004-04 Q2M Clamp D6 half + bullone 14 mm • M004-74 Q2M Rod D6 50 mm (1 pezzo) • M012-40 Hand Warmer dual lock (22*9*3,5 mm): 2 pezzi • M004-90 Q2M Rod D6-D8 60mm

Manuale utente per Hand Warmer D-P012-62-70-MX

Manuale di installazione Hand Warmer D-P012-62-70-M1

Accessori opzionali: Hand Warmer Dome set (M012-31)

Per racchiudere l'area intorno alla mano e per mantenere al meglio la temperatura dell'aria, è disponibile come optional una cappa in Perspex a forma di cupola.

Questa cupola:

- riduce le dispersioni termiche, con conseguente diminuzione del consumo energetico, senza compromettere il comfort.
- viene fornita con 4 cuscinetti di fissaggio a strappo per il fissaggio a qualsiasi superficie piana (ad es. un vassoio).
- è dotata di un'apertura che può essere facilmente regolata, poiché il Perspex è un materiale che può essere tagliato o rasato.



AVVERTENZA: Utilizzare strumenti adeguati per regolare le aperture della cupola. La garanzia decade per qualsiasi difetto dovuto alla regolazione della cupola.

Qualifiche



AVVERTENZA: Il dispositivo può essere installato solo da un tecnico qualificato.



AVVERTENZA: La programmazione errata dell'elettronica della sedia a rotelle o del dispositivo potrebbe causare danni al dispositivo stesso e lesioni all'utilizzatore.

Primo utilizzo



AVVERTENZA: Per il primo utilizzo è importante l'assistenza di un tecnico qualificato che spiegherà chiaramente tutte le funzioni e cosa fare in caso di problemi.

Pulizia



AVVERTENZA: As dust and dirt could lead to reduced functionality, all parts of the device should be cleaned on a regular basis (monthly) or whenever needed.

- Gently remove dust and dirt with a damp cloth.
- Use only non-aggressive disinfectant cleaning agents.



AVVERTENZA: Do not immerse in water or use excessive amounts of liquid.

Avvertenze e limiti



NOTA: This product complies with the limit values for Electromagnetic Compatibility (EMC) with respect to power wheelchairs, as set out in the harmonized standards for the EU in the Medical Device Regulation, No. 2017/745.



AVVERTENZA:

At full power, the device will produce warm air (up to 80°C/158°F). It is advised to leave a minimum distance between the hand and the Hand Warmer of at least 10 cm (4 in).



Se la distanza è inferiore, è necessario limitare la temperatura massima del riscaldatore (consultare il *manuale di installazione*).



AVVERTENZA: Controllare quotidianamente che il Hand Warmer sia ancora nella posizione corretta e ad almeno 10 cm di distanza dalle mani.

Dimensioni

Hand Warmer unit

50 mm x 29 mm x 29 mm - 1,97 pollici x 1,41 pollici x 1,41 pollici (AxLxP)

Hand Warmer Dome

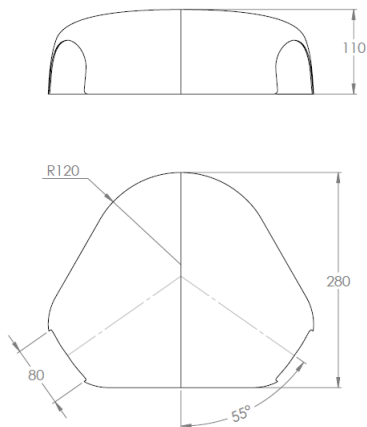

Brukerhåndbok (Norsk)

Advarselsetiketter

Les denne håndboken, sikkerhetsinstruksjonene og advarslene nøye for å redusere risikoen som er forbundet med enheten. Våre produkter er sikre under normale driftsforhold og driftsforhold som med rimelighet kan forutses.



MERK: Dette symbolet indikerer generelle merknader og informasjon.



ADVARSEL: Dette symbolet indikerer en advarsel om en farlig situasjon som kan føre til mindre eller moderat personskade hvis den ikke unngås.



ADVARSEL: Dette symbolet indikerer en advarsel om en farlig situasjon som kan føre til dødsfall eller alvorlig personskade hvis den ikke unngås.

Brukerstøtte, kassering og gjenvinning

Teknisk støtte



PROBLEM: In case of technical problems:

- Kontakt forhandleren
- Hvis forhandleren er ukjent eller ikke tilgjengelig, kan mo-vis kontaktes: contact@mo-vis.com eller +32 9 335 28 60.

Always state the product code and device serial number when contacting us. This ensures you are provided with the correct information.

Reservedeler og tilbehør

Contact mo-vis or your dealer for more information about spare parts and accessories.

Kassering og gjenvinning



ADVARSEL: Følg lokale bestemmelser for kassering. Gamle elektroniske deler må kasseres på en ansvarlig måte i henhold til lokale gjenvinningsbestemmelser.

Begrenset ansvar

*mo-vis påtar seg **intet ansvar** for personskade eller skade på eiendom som følge av at brukeren eller andre personer har unnlatt å følge anbefalingene, advarslene og instruksjonene i denne håndboken.*



ADVARSEL: Dette produktet skal kun installeres av en kvalifisert servicetekniker.



MERK: Alle håndbøker fra mo-vis er tilgjengelige i PDF-format på <http://www.mo-vis.com>.



MERK: Hvis det oppstår en alvorlig hendelse i forbindelse med denne enheten, skal det rapporteres umiddelbart til mo-vis og kompetent myndighet i brukerens hjemland.

Bruksområde

Hand Warmerens hovedfunksjon er å holde området rundt styreenheten på en rullestol varmt. Dette gir bedre brukerkomfort og forbedrer brukerens betjening av styreenheten.

Den er ment for montering på alle rullestoler med 24 V-tilkobling.

Funksjoner

Hand Warmer:

- er en luftvarmer som drives av batterispenningen (24 V) til en motorisert rullestol.
- is fully adjustable to individual possibilities and needs with well-thought-out electronics (mini USB connection).
- resirkulerer luft i stedet for å bruke kald luft fra omgivelsene: den trekker inn luft foran, varmer den opp og tvinger den ut igjen foran ved hjelp av en intern vifte. Dette gir store fordeler med tanke på strømforbruk og effektivitet.
- en mekanisk bryter (f.eks. mo-vis Twister) kan enkelt plugges inn (på/av, valg av effektnivåer), men du har også en innebygd trykknapp.
- LED-lampen viser enhetens status.



MERK: Et kuppelformet deksel i pleksiglass for begge hender er tilgjengelig for å holde bedre på varmen rundt hendene.

Betjening

Enheten er utstyrt med en jack-kontakt (1) og en trykknapp (2) på baksiden.



En knapp som kobles til jack-kontakten har samme funksjonalitet som den innebygde trykknappen.

Knappens funksjon er å bla gjennom enhetens nivåer (effektinnstillinger). Se mer informasjon i *installasjonshåndboken*.

De grønne LED-indikatorene på fronten viser enhetens status:

MODUS	LED-INDIKATOR
Dvalemodus	Av
Standby	Kort på, svært langt av
Aktiv nivå 1	Kort på, langt av
Aktiv nivå 2	Kort på, middels av
Aktiv nivå 3	Kort på, kort av
Feil	antall blink, langt av (se mer informasjon om feil og feillogg i <i>installasjonshåndboken</i>)

Deler og tilbehør

Hand Warmer set

Et Hand Warmer set består av følgende deler:

EKSEMPEL**PRODUKTBESKRIVELSE**

P012-61 Hand Warmer unit



P012-40 Hand Warmer extension
lead 2000 mm

EKSEMPEL	PRODUKTBEKRIVELSE
	<p>M012-45 Hand Warmer mounting set:</p> <ul style="list-style-type: none"> • M004-04 Q2M Clamp D6 half + bolt 14 mm • M004-74 Q2M Rod D6 50 mm (1 stk.) • M012-40 Hand Warmer dual lock (22*9*3,5 mm): 2 stk. • M004-90 Q2M Rod D6-D8 60mm

Brugerhåndbok for D-P012-62-70-MX Hand Warmer

Installasjonshåndbok for D-P012-62-70-M9 Hand Warmer

Valgfritt tilbehør: Hand Warmer Dome set (M012-31)

En kuppelformet hette i pleksiglass er tilgjengelig som tilbehør for å beskytte området rundt hånden og opprettholde lufttemperaturen.

Denne kuppelen:

- Reduserer varmetap og gir lavere strømforbruk uten at det går ut over komforten.
- leveres med 4 borrelåsputer for montering av kuppelen på et flatt underlag (f.eks. et brett).
- har en åpning som enkelt kan justeres ved å skjære eller slipe til pleksiglasset.



ADVARSEL: Bruk egnet verktøy til å justere åpningene i kuppelen. Garantien dekker ikke feil som skyldes justering av kuppelen.

Kvalifikasjoner



ADVARSEL: Enheten skal kun installeres av en kvalifisert servicetekniker.



ADVARSEL: Feil programmering av elektronikken i rullestolen eller enheten kan føre til skade på enhetene eller personskaade på brukeren.

Første gangs bruk



ADVARSEL: En kvalifisert servicetekniker bør bistå under første gangs bruk av enheten, og forsikre seg om at brukeren er kjent med alle

funksjonene, inkludert hva som skal gjøres hvis det oppstår problemer eller tvil.

Rengjøring



ADVARSEL: As dust and dirt could lead to reduced functionality, all parts of the device should be cleaned on a regular basis (monthly) or whenever needed.

- Gently remove dust and dirt with a damp cloth.
- Use only non-aggressive disinfectant cleaning agents.



ADVARSEL: Do not immerse in water or use excessive amounts of liquid.

Advarsler og begrensninger



MERK: This product complies with the limit values for Electromagnetic Compatibility (EMC) with respect to power wheelchairs, as set out in the harmonized standards for the EU in the Medical Device Regulation, No. 2017/745.



ADVARSEL:

At full power, the device will produce warm air (up to 80°C/158°F). It is advised to leave a minimum distance between the hand and the Hand Warmer of at least 10 cm (4 in).



Hvis det er kort avstand, må varmerens maksimumstemperatur begrenses (se *installasjonshåndboken*).



ADVARSEL: Kontroller daglig at Hand Warmeren står i riktig posisjon og er minst 10 cm fra hendene.

Mål

Hand Warmer unit

50 mm x 29 mm x 29 mm - 1,97 tommer x 1,41 tommer x 1,41 tommer (HxBxD)

Hand Warmer Dome

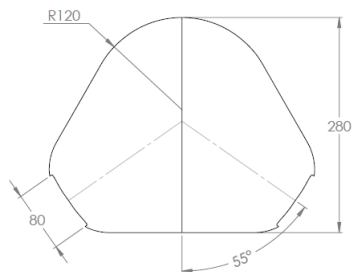

Gebruikershandleiding (Nederlands)

Waarschuwingsetabels

Lees deze handleiding, de veiligheidsvoorschriften en waarschuwingen zorgvuldig, zodat de risico's met betrekking tot het apparaat worden vermindert. Onze producten zijn onder normale en redelijke bedrijfsomstandigheden veilig.



OPMERKING: Dit symbool geeft een algemene opmerking en informatie weer.



LET OP! Dit symbool geeft een waarschuwing voor een gevaarlijke situatie weer die, als deze niet wordt vermeden, gering of middelmatig letsel tot gevolg kan hebben.



ATTENTIE: Dit symbool geeft een waarschuwing voor een gevaarlijke situatie weer die, als deze niet wordt vermeden, overlijden of ernstig letsel tot gevolg kan hebben.

Ondersteuning, afdanken en recycling

Technische ondersteuning



PROBLEEM: In case of technical problems:

- Neem contact op met uw dealer
- Als de dealer niet beschikbaar is of u niet weet wie de dealer is, neem dan contact op met mo-vis via contact@mo-vis.com of +32 9 335 28 60.

Always state the product code and device serial number when contacting us. This ensures you are provided with the correct information.

Reserveonderdelen en accessoires

Contact mo-vis or your dealer for more information about spare parts and accessories.

Afdanken en recyclen



LET OP!: Neem bij afdanken de plaatselijke afvalvoorschriften in acht. Gooi overbodige elektronische onderdelen op een verantwoorde wijze weg en in overeenstemming met de plaatselijke recyclingvoorschriften.

Beperkte aansprakelijkheid

*mo-vis accepteert **geen aansprakelijkheid** voor persoonlijk letsel of eigendomsschade als gevolg van het niet opvolgen door de gebruiker of anderen van de aanbevelingen, waarschuwingen en instructies in deze handleiding.*



LET OP!: Dit product mag uitsluitend door een bevoegde servicemonteur worden geïnstalleerd.



OPMERKING: Alle mo-vis-handleidingen zijn op <http://www.mo-vis.com> te vinden, waar ze als pdf kunnen worden ingezien.



OPMERKING: Indien er met dit apparaat een ernstig ongeval optreedt, moet dit onmiddellijk worden gemeld aan mo-vis en de bevoegde autoriteit van de lidstaat waar de gebruiker is gevestigd.

Beoogd gebruik

De hoofdfunctie van de Hand Warmer is om de omgeving rond een invoerapparaat van de rolstoel warm te houden. Dat verhoogt het comfort van de gebruikers en hun vermogen om het invoerapparaat te bedienen.

Het kan op iedere elektrische rolstoel met een 24 V-aansluiting worden gemonteerd.

Eigenschappen

De Hand Warmer:

- is een luchtverwarming die door de accu (24 V) van een elektrische rolstoel wordt gevoed.
- is fully adjustable to individual possibilities and needs with well-thought-out electronics (mini USB connection).
- recyclet lucht in plaats van lucht uit een koude omgeving te gebruiken. Het zuigt aan de voorkant lucht aan, verwarmt het en blaast het met behulp van een interne ventilator aan de voorkant weer uit. Dat levert een enorm voordeel op met betrekking tot stroomverbruik en efficiëntie.
- er kan direct een mechanische schakelaar (bijv. mo-vis Twister) worden ingeplugd (aan/uit, keuze vermogensniveaus), hoewel er ook een ingebouwde drukknop is.
- Een led geeft de status van het apparaat aan.



OPMERKING: Er is een Perspex koepelvormige kap voor twee handen leverbaar, waardoor de luchttemperatuur rond de handen beter op peil wordt gehouden.

Bediening

Aan de achterzijde van het apparaat zijn een jackplugaansluiting (1) en een drukknop (2) aangebracht.



Een knop die verbonden is met de jackplugaansluiting heeft dezelfde functie als de drukknop op het apparaat.

De functie van de knop is om de niveaus (vermogensinstellingen) van het apparaat te doorlopen. Zie voor meer informatie de *Installatiehandleiding*.

Het groene ledlampje aan de voorzijde geeft de status van het apparaat aan:

MODUS	LEDINDICATOR
Slaapstand	Uit
Stand-by	Kort aan, zeer lang uit
Actief niveau 1	Kort aan, lang uit
Actief niveau 2	Kort aan, middellang uit
Actief niveau 3	Kort aan, kort uit
Fout	aantal keer knipperen, lang uit (zie voor meer informatie over fouten en het logbestand van fouten de <i>Installatiehandleiding</i>)

Onderdelen en accessoires

Hand Warmer set

Een Hand Warmer set bevat de volgende onderdelen:

VOORBEELD**PRODUCTBESCHRIJVING**

P012-61 Hand Warmer unit



P012-40 Hand Warmer extension
lead 2000 mm

VOORBEELD	PRODUCTBESCHRIJVING
	<p>M012-45 Hand Warmer mounting set:</p> <ul style="list-style-type: none"> • M004-04 Q2M Clamp D6 half + bout 14 mm • M004-74 Q2M Rod D6 50 mm (1 stuks) • M012-40 Hand Warmer dual lock (22*9*3,5 mm): 2 stuks • M004-90 Q2M Rod D6-D8 60mm

D-P012-62-70-MX Gebruikershandleiding Hand Warmer

D-P012-62-70-M1 Installatiehandleiding Hand Warmer

Optionele accessoire: Hand Warmer Dome set (M012-31)

Om de omgeving rond de hand af te sluiten en de luchttemperatuur beter op peil te houden, is er optioneel een koepelvormige Perspex-kap leverbaar.

Deze koepel:

- vermindert warmteverlies, wat voor een lager stroomverbruik zorgt, zonder aan het comfort afbreuk te doen.
- wordt met vier klittenbandstroken geleverd waarmee de koepel op een vlak oppervlak (bijv. een plateau) kan worden bevestigd.
- heeft een opening die gemakkelijk kan worden aangepast omdat Perspex een materiaal is dat kan worden gesneden of geschaafd.



LET OP! Gebruik het juiste gereedschap om de opening van de koepel aan te passen. De garantie vervalt voor schade als gevolg van het aanpassen van de koepel.

Bevoegdheden



LET OP! Het apparaat mag alleen door een bevoegde servicemonteur worden geïnstalleerd.



LET OP! Het onjuist programmeren van de elektronica van de rolstoel of het apparaat kan schade aan de apparaten of letsels bij de gebruiker veroorzaken.

Eerste gebruik



LET OP!: Bij het eerste gebruik van het apparaat moet een bevoegde servicemonteur helpen en ervoor zorgen dat alle functies voor de gebruiker duidelijk zijn, waaronder wat te doen bij problemen of twijfels.

Reinigen



ATTENTIE: As dust and dirt could lead to reduced functionality, all parts of the device should be cleaned on a regular basis (monthly) or whenever needed.

- Gently remove dust and dirt with a damp cloth.
- Use only non-aggressive disinfectant cleaning agents.



LET OP!: Do not immerse in water or use excessive amounts of liquid.

Waarschuwingen en beperkingen



OPMERKING: This product complies with the limit values for Electromagnetic Compatibility (EMC) with respect to power

wheelchairs, as set out in the harmonized standards for the EU in the Medical Device Regulation, No. 2017/745.



ATTENTIE:

At full power, the device will produce warm air (up to 80°C/158°F). It is advised to leave a minimum distance between the hand and the Hand Warmer of at least 10 cm (4 in).



Als de afstand kleiner is, moet de maximale temperatuur van de verwarming worden beperkt (zie de *Installatiehandleiding*).



ATTENTIE: Controleer dagelijks of de Hand Warmer zich nog in de juiste positie bevindt en tenminste 10 cm van de handen verwijderd is.

Afmetingen

Hand Warmer unit

50 x 29 x 29 mm - 1,97 x 1,41 x 1,41 inch (HxBxD)

Hand Warmer Dome

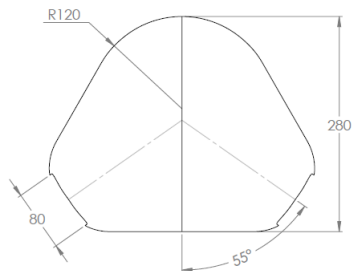

Manual do utilizador (Português)

Rótulos com advertências

Leia atentamente este manual, as instruções de segurança, os textos de advertência de modo a reduzir os riscos associados ao dispositivo. Os nossos produtos são seguros em condições de operação normais e razoavelmente previsíveis.



NOTA: Este símbolo indica as notas gerais e informação.



CUIDADO: Este símbolo indica cuidado em relação a uma situação perigosa que, se não for evitada, pode resultar em ferimentos reduzidos ou médios.



AVISO: Este símbolo indica um aviso em relação a uma situação perigosa que, se não for evitada, pode resultar em morte ou ferimentos graves.

Suporte, eliminação e reciclagem

Suporte técnico



PROBLEMA: In case of technical problems:

- Contacte o seu revendedor
- Se o seu revendedor não estiver disponível ou for desconhecido, contacte a mo-vis através do: contact@mo-vis.com ou do +32 9 335 28 60.

Always state the product code and device serial number when contacting us. This ensures you are provided with the correct information.

Peças sobresselentes e acessórios

Contact mo-vis or your dealer for more information about spare parts and accessories.

Eliminação e reciclagem



CUIDADO: Para a eliminação, siga a sua legislação local relativa a resíduos. Elimine as peças eletrónicas obsoletas de modo responsável e de acordo com os regulamentos relativos à reciclagem locais.

Responsabilidade limitada

A mo-vis não **assume qualquer responsabilidade** por danos pessoais ou de propriedade que possam advir da falha no seguimento da recomendação, avisos e instruções neste manual por parte do utilizador ou de outras pessoas.



CUIDADO: Este produto só deve ser instalado por um engenheiro de assistência qualificado.



NOTA: Todos os manuais da mo-vis podem ser encontrados em <http://www.mo-vis.com> onde podem ser consultados em formato PDF.



NOTA: Caso ocorra algum acidente grave relativo a este dispositivo, o mesmo deve ser reportado imediatamente à mo-vis e à autoridade competente do estado-membro no qual o utilizador reside.

Utilização prevista

A principal funcionalidade do Hand Warmer é manter a área em redor do dispositivo de introdução da cadeira de rodas quente. Tal aumenta o conforto dos utilizadores e a sua capacidade de controlar o dispositivo de introdução.

Está concebido para ser integrado em qualquer cadeira motorizada com uma ligação de 24V.

Funcionalidades

O Hand Warmer:

- é um aquecedor de ar, alimentado pela energia da bateria (24V) de uma cadeira motorizada.
- is fully adjustable to individual possibilities and needs with well-thought-out electronics (mini USB connection).
- recicla o ar em vez usar o ar frio do ambiente: suga o ar pela parte frontal, aquece-o e expõe-o novamente pela parte frontal através de uma ventoinha interna. Isto resulta numa grande vantagem no que diz respeito ao consumo de energia e a eficiência.
- um interruptor mecânico (por ex., mo-vis Twister) pode ser conectado imediatamente (lig/des seleccionar os níveis de energia), apesar que também possui um botão de pressão integrado.
- Um LED indica o estado do dispositivo.



NOTA: Está disponível uma tampa Perspex para as 2 mãos em forma de cúpula para manter melhor a temperatura do ar em torno das suas mãos.

Funcionamento

São fornecidos, na parte traseira do dispositivo, uma ligação de conector (1) e um botão de pressão (2).



Um botão conectado à ligação de conector possui a mesma função que o botão de pressão integrado.

A função do botão é a de navegar pelos níveis (definições de potência) do dispositivo. Consulte o *Manual de Instalação* para obter mais informações.

O LED verde frontal indica o estado do dispositivo:

MODO	INDICADOR LED
Modo de suspensão	Desligado
Em espera	Ativação curta, desativação muito longa
Nível de ativação 1	Ativação curta, desativação longa
Nível de ativação 2	Ativação curta, desativação média
Nível de ativação 3	Ativação curta, desativação curta
Falha	Número de intermitências, desativação longa (consulte o <i>Manual de instalação</i> para obter mais informações no registo de erros e falhas)

Peças e acessórios

Hand Warmer set

Um Hand Warmer set contém as seguintes peças:

EXEMPLO**DESCRIÇÃO DO PRODUTO**

P012-61 Hand Warmer unit



P012-40 Hand Warmer extension lead 2000 mm



EXEMPLO	DESCRIÇÃO DO PRODUTO
	<p>M012-45 Hand Warmer mounting set:</p> <ul style="list-style-type: none"> • M004-04 Q2M Clamp D6 half + bolt 14 mm • M004-74 Q2M Rod D6 50 mm (1 peça) • M012-40 Hand Warmer dual lock (22*9*3,5 mm): 2 peças • M004-90 Q2M Rod D6-D8 60mm

Manual do utilizador do D-P012-62-70-MX Hand Warmer

Manual de instalação D-P012-62-70-M1 Hand Warmer

Acessório opcional: Hand Warmer Dome set (M012-31)

Para fechar a área em torno da mão, e para melhor manter a temperatura do ar, está disponível como opção uma tampa Perspex em forma de cúpula.

Esta cúpula:

- reduz a perda de calor, resultado num reduzido consumo de energia, sem comprometer o conforto.
- é fornecida com 4 almofadas de fixação de gancho e laço para fixar a cúpula em qualquer superfície plana (por ex., tabuleiro).
- possui uma abertura que pode ser facilmente ajustada já que Perspex é um material que pode ser cortado ou raspado.



CUIDADO: Utilize as ferramentas adequadas para ajustar as aberturas da cúpula. A garantia é anulada em caso de anomalia resultante do ajuste da cúpula.

Qualificações



CUIDADO: Apenas um engenheiro de assistência qualificado pode instalar o dispositivo.



CUIDADO: Uma programação incorreta da cadeira de rodas ou do sistema eletrónico do dispositivo pode danificar os dispositivos ou ferir o utilizador.

Primeira utilização



CUIDADO: Um engenheiro de assistência qualificado deve prestar apoio na primeira utilização do dispositivo e certificar-se de que todas as funções são claras para o utilizador, incluindo o que fazer em caso de problemas ou dúvidas.

Limpeza



AVISO: As dust and dirt could lead to reduced functionality, all parts of the device should be cleaned on a regular basis (monthly) or whenever needed.

- Gently remove dust and dirt with a damp cloth.
- Use only non-aggressive disinfectant cleaning agents.



CUIDADO: Do not immerse in water or use excessive amounts of liquid.

Avisos e limitações



NOTA: This product complies with the limit values for Electromagnetic Compatibility (EMC) with respect to power wheelchairs, as set out in

the harmonized standards for the EU in the Medical Device Regulation, No. 2017/745.



AVISO:

At full power, the device will produce warm air (up to 80°C/158°F). It is advised to leave a minimum distance between the hand and the Hand Warmer of at least 10 cm (4 in).



Se a distância for inferior, é necessário limitar a temperatura máxima do aquecedor (consulte o *Manual de instalação*).



AVISO: Verifique diariamente se o Hand Warmer ainda se encontra na sua posição correta e se está afastado pelo menos 10 cm das mãos.

Dimensões

Hand Warmer unit

50 mm x 29 mm x 29 mm - 1,97 pol. x 1,41 pol. x 1,41 pol. (AxLxP)

Hand Warmer Dome

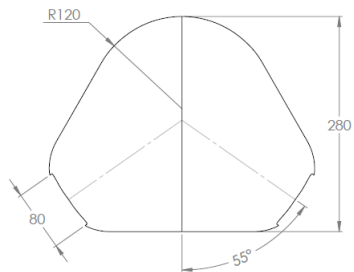

Användarhandbok (Svenska)

Varningsetiketter

Läs denna handbok, säkerhetsinstruktionerna och varningstexterna noggrant för att minska riskerna med anknytning till enheten. Våra produkter är säkra under normala och rimligen förutsebara driftsförhållanden.



ANM: Denna symbol anger allmänna anmärkningar och information.



VARNING - RISK FÖR PERSONSKADA: Denna symbol visar att man ska vara försiktig inför en riskfylld situation som, om den inte undviks, kan leda till mindre eller måttlig skada.



VARNING - RISK FÖR MASKINSKADA: Denna symbol visar en varning inför en riskfylld situation som, om den inte undviks, kan leda till dödsfall eller allvarlig skada.

Support, kassering och återvinning

Teknisk support



PROBLEM: In case of technical problems:

- Kontakta din återförsäljare
- Om din återförsäljare inte är tillgänglig eller okänd ska du kontakta mo-vis: contact@mo-vis.com eller ringa +32 9 335 28 60.

Always state the product code and device serial number when contacting us. This ensures you are provided with the correct information.

Reservdelar och tillbehör

Contact mo-vis or your dealer for more information about spare parts and accessories.

Kassering och återvinning



WARNING - RISK FÖR PERSONSKADA: Följ den lokala avfallslagstiftningen för kassering. Kassera föråldrade elektroniska delar på ett ansvarsfullt sätt i enlighet med lokala återvinningsbestämmelser.

Begränsat ansvar

Mo-vis tar **inget ansvar** för personskada eller egendomsskada som kan uppstå på grund av att användaren eller andra personer inte har följt rekommendationerna, varningarna och instruktionerna i denna handbok.



VARNING - RISK FÖR PERSONSKADA: Denna produkt får endast installeras av en behörig servicetekniker.



ANM: Alla mo-vis handböcker finns på <http://www.mo-vis.com> där de finns tillgängliga i PDF-format.



ANM: Om en allvarlig incident inträffar i samband med den här enheten ska detta omedelbart rapporteras till mo-vis och den behöriga myndigheten i den medlemsstat där användaren är bosatt.

Avsedd användning

Hand Warmers huvudfunktion är att hålla området runt en rullstols styrenhet varmt. Det ökar komforten för användarna och deras förmåga att hantera kontrollenheten.

Den är avsedd att monteras på elrullstolar med en 24 V kontakt.

Funktioner

Hand Warmer:

- är en batteridrivna (24 V) luftvärmare för en elrullstol.
- is fully adjustable to individual possibilities and needs with well-thought-out electronics (mini USB connection).
- Återcirkulerar luft istället för att använda luft från den kalla omgivningen: den suger in luft på framsidan, värmer upp den och använder en intern fläkt till att tvinga ut den igen på framsidan. Det leder till en stor fördel avseende energiförbrukning och effektivitet.
- en mekanisk omkopplare (t.ex. mo-vis Twister) kan kopplas in omedelbart (på/av, välja effektnivåer) även om du även har en inbyggd tryckknapp.
- Lysdioder visar enhetens status.



ANM: En kupformad kåpa för två händer av märket Perspex finns tillgänglig. Den behåller lufttemperaturen runt händerna bättre.

Användning

På enhetens baksida sitter ett uttag (1) och en knapp (2).



En knapp som anslutits uttaget fungerar på samma sätt som tryckknappen ombord.

Knappens funktion är att gå igenom enhetens nivåer (ströminställningar). Mer information finns i *Installationshandboken*.

Den gröna lysdioden på framsidan indikerar enhetens status:

LÄGE	LED-INDIKATOR
Viloläge	Av
Vänteläge	Kort på, mycket lång av
Aktiv nivå 1	Kort på, lång av
Aktiv nivå 2	Kort på, medellång av
Aktiv nivå 3	Kort på, kort av
Fel	Antal blinkningar, lång av (se <i>Installationshandboken</i> för mer information om felloggen)

Delar och tillbehör

Hand Warmer set

Ett Hand Warmer set innehåller följande delar:

EXEMPEL**PRODUKTBESKRIVNING**

P012-61 Hand Warmer unit



P012-40 Hand Warmer extension
lead 2000 mm

EXEMPEL	PRODUKTBESKRIVNING
	<p>M012-45 Hand Warmer mounting set:</p> <ul style="list-style-type: none"> • M004-04 Q2M Clamp D6 half + bult 14 mm • M004-74 Q2M Rod D6 50 mm (1 del) • M012-40 Hand Warmer dual lock (22*9*3,5 mm): 2 delar • M004-90 Q2M Rod D6-D8 60mm

Användarhandbok till D-P012-62-70-MX Hand Warmer

Installationshandbok till D-P012-62-70-M1 Hand Warmer

Tillvalstillbehör: Hand Warmer Dome set (M012-31)

För att inhägnat området runt handen och för att bättre bibehålla lufttemperaturen finns en kupolformad kåpa av Perspex tillgänglig som alternativ.

Den här kåpan:

- minskar värmeförlust, vilket leder till minskad strömförbrukning utan försämrad komfort.
- levereras med fyra kardborrspännen för att montera kåpan på valfri platt yta (t.ex. en bricka).
- Har en öppning som enkelt går att justera eftersom Perspex är ett material som går att klippa eller trimma.



WARNING - RISK FÖR PERSONSKADA: Använd riktiga verktyg för att justera kåpans öppningar. Garantin hävs vid fel till följd av justering av kåpan.

Behörighet



WARNING - RISK FÖR PERSONSKADA: Endast en behörig servicetekniker bör installera enheten.



WARNING - RISK FÖR PERSONSKADA: Felaktig programmering av rullstolens eller enhetens elektronik kan orsaka skador på enheterna eller skada användaren.

Första användningen



WARNING - RISK FÖR PERSONSKADA: En behörig servicetekniker ska hjälpa till vid första användningen av enheten och se till att alla funktioner är tydliga för användaren, dessutom vad användaren ska göra vid problem eller tveksamheter.

Rengöring



WARNING - RISK FÖR MASKINSKADA: As dust and dirt could lead to reduced functionality, all parts of the device should be cleaned on a regular basis (monthly) or whenever needed.

- Gently remove dust and dirt with a damp cloth.
- Use only non-aggressive disinfectant cleaning agents.



WARNING - RISK FÖR PERSONSKADA: Do not immerse in water or use excessive amounts of liquid.

Varningar och begränsningar



ANM: This product complies with the limit values for Electromagnetic Compatibility (EMC) with respect to power wheelchairs, as set out in the harmonized standards for the EU in the Medical Device Regulation, No. 2017/745.



VARNING - RISK FÖR MASKINSKADA:

At full power, the device will produce warm air (up to 80°C/158°F). It is advised to leave a minimum distance between the hand and the Hand Warmer of at least 10 cm (4 in).



Om avståndet är kortare är det nödvändigt att begränsa värmarens maximala temperatur (se *Installationshandboken*).



VARNING - RISK FÖR MASKINSKADA: Kontrollera dagligen huruvida Hand Warmer fortfarande sitter i rätt läge och minst 10 cm från händerna.

Mått

Hand Warmer unit

50 mm x 29 mm x 29 mm – 1,97 tum x 1,41 tum x 1,41 tum (HxBxD)

Hand Warmer Dome

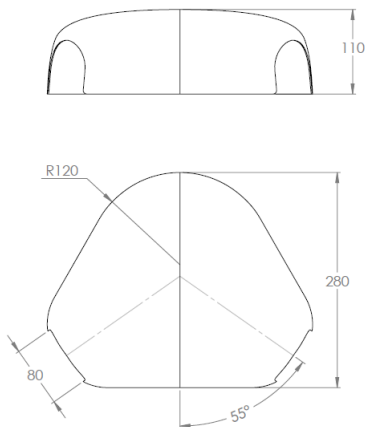



mo-vis bv . Biebuyckstraat 15D . 9850 Deinze - Belgium

www.mo-vis.com . contact@mo-vis.com . +32 9 335 28 60

Go to our website for more information on our products or share your experience with us via email.

